

N° PGE	CLIENT: IVB MERY SUR SEINE Réf. C.de: Mail du 20/06/2016 de Mr SIX	DATE : 10/10/2016	FOURS H&C	RESISTANCES ZONES 1 ET 2
01				

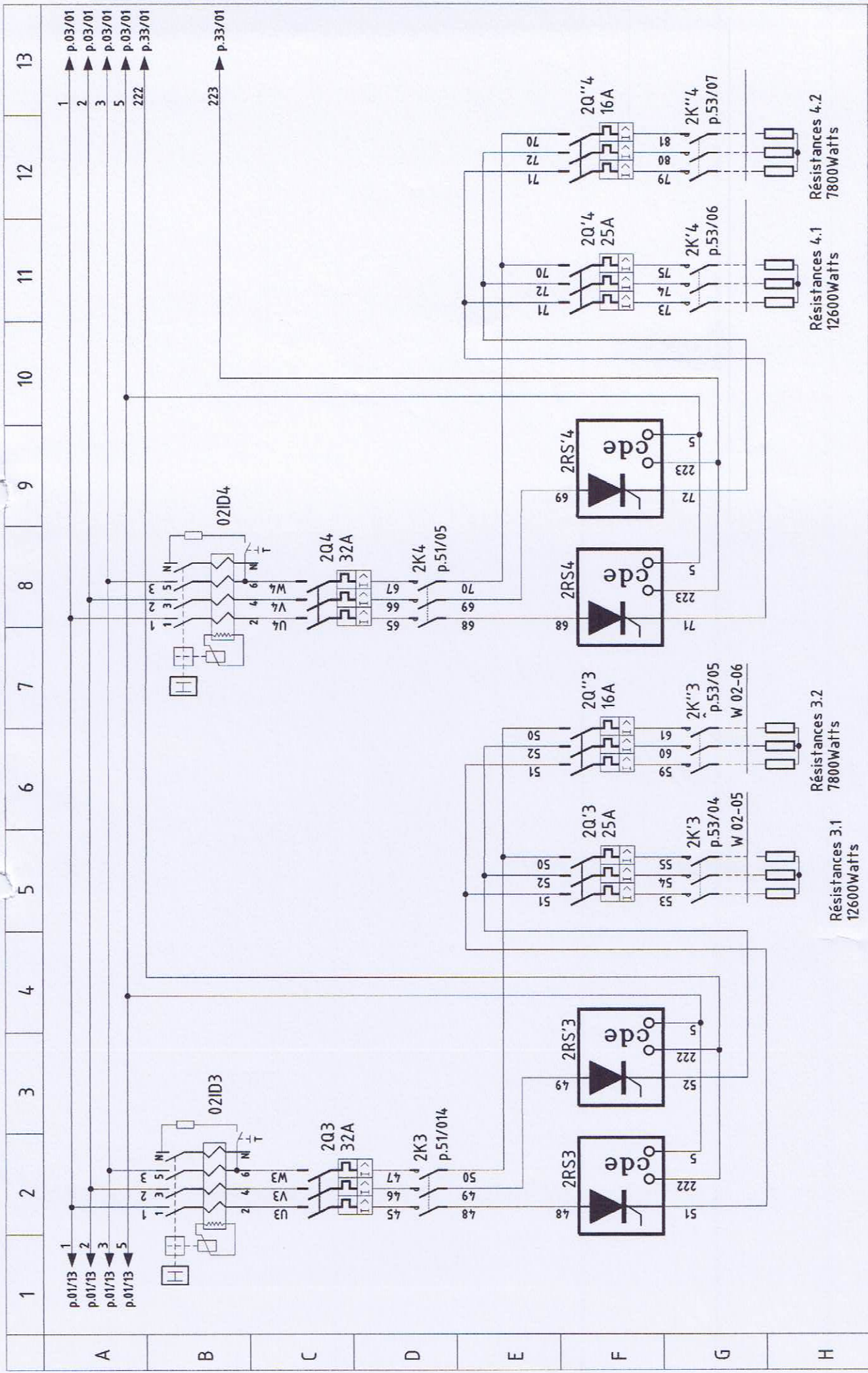

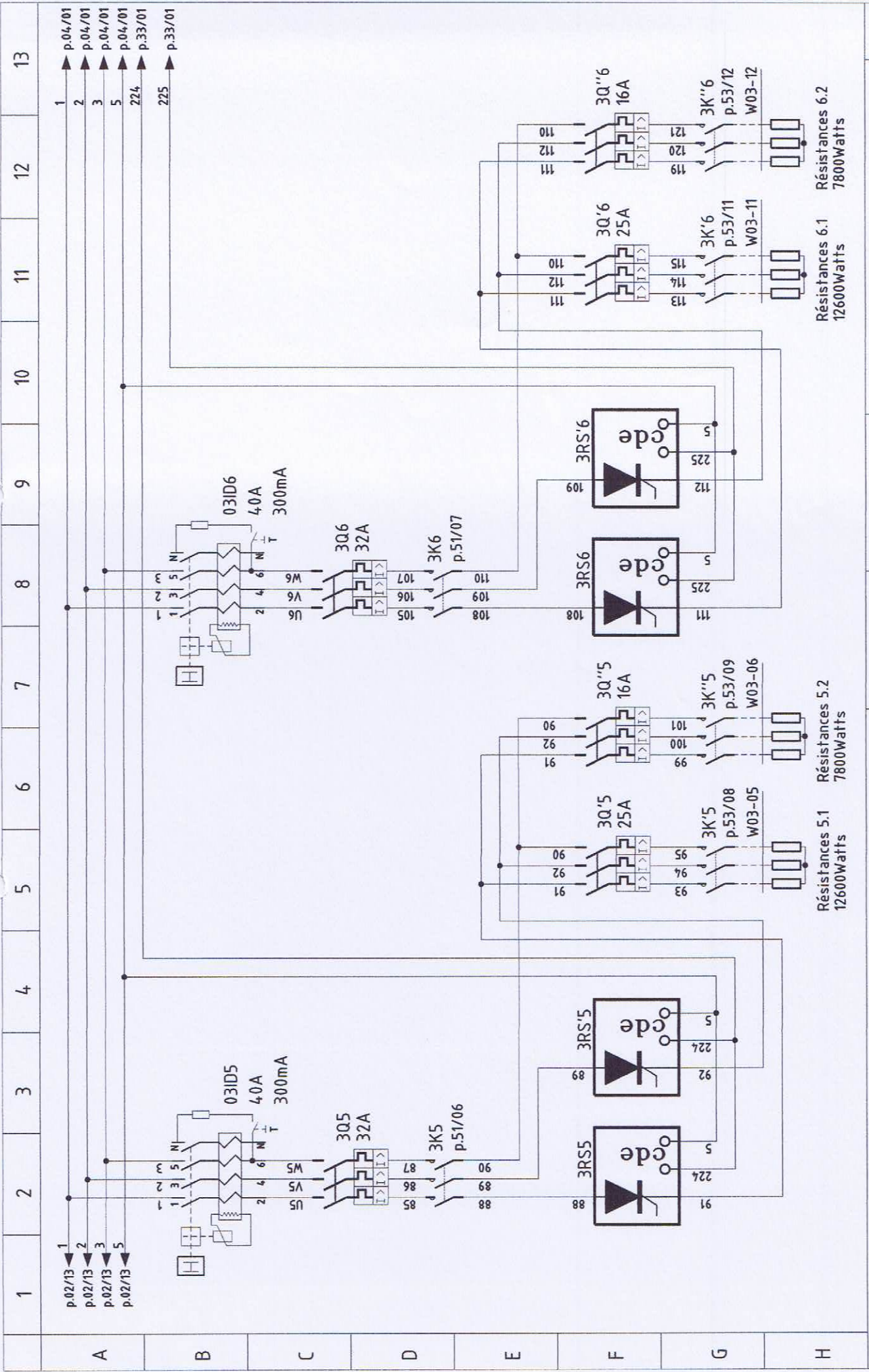

1 p.02/13
 2 p.02/13
 3 p.02/13
 5 p.02/13

1 p.04/01
 2 p.04/01
 3 p.04/01
 5 p.04/01
 224 p.33/01
 225 p.33/01

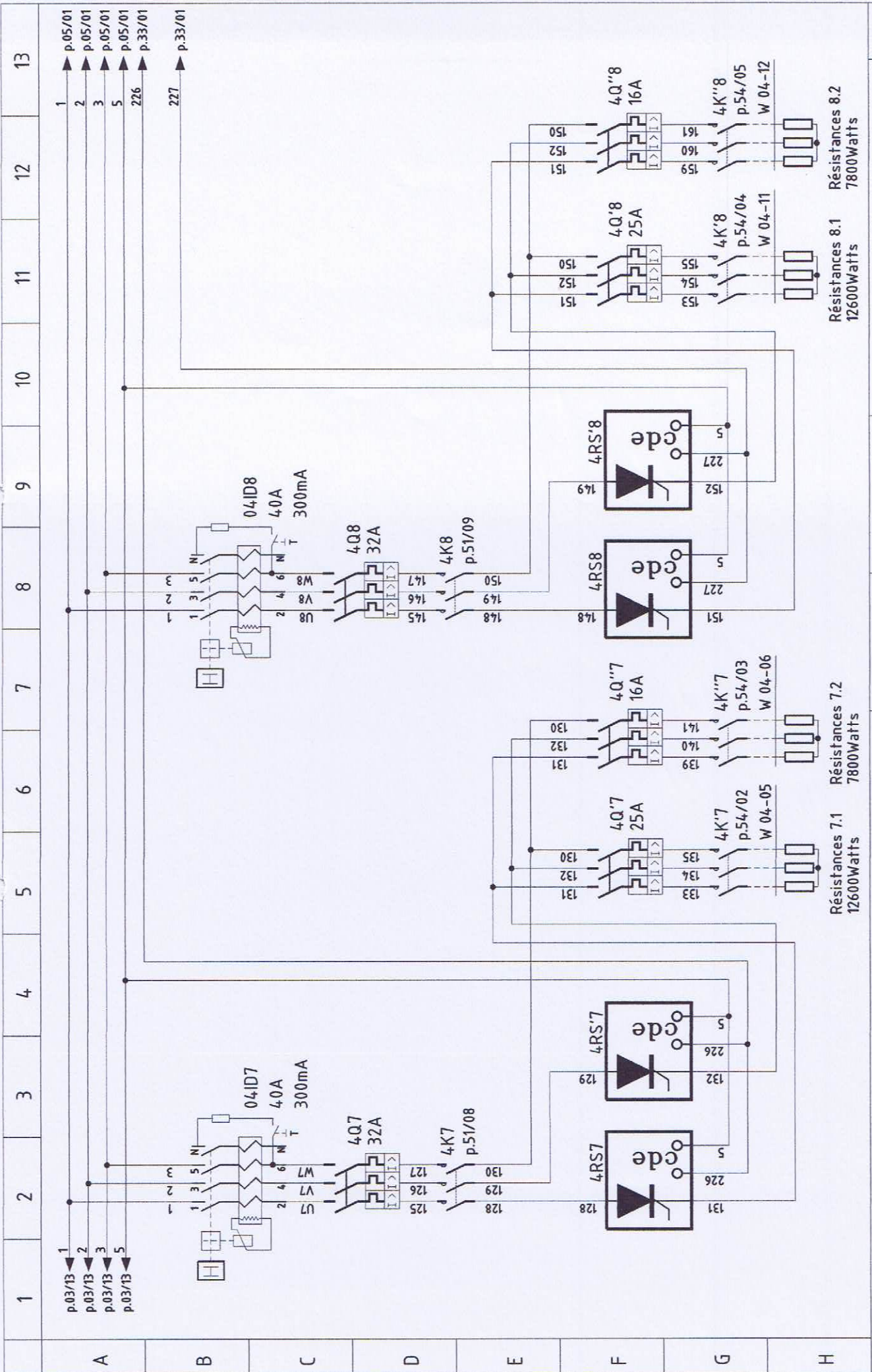

1 p.03/13
 2 p.03/13
 3 p.03/13
 5 p.03/13

1 p.05/01
 2 p.05/01
 3 p.05/01
 5 p.05/01
 226 p.33/01
 227 p.33/01

A

B

C

D

E

F

G

H

1 2 3 4 5 6 7 8 9 10 11 12 13

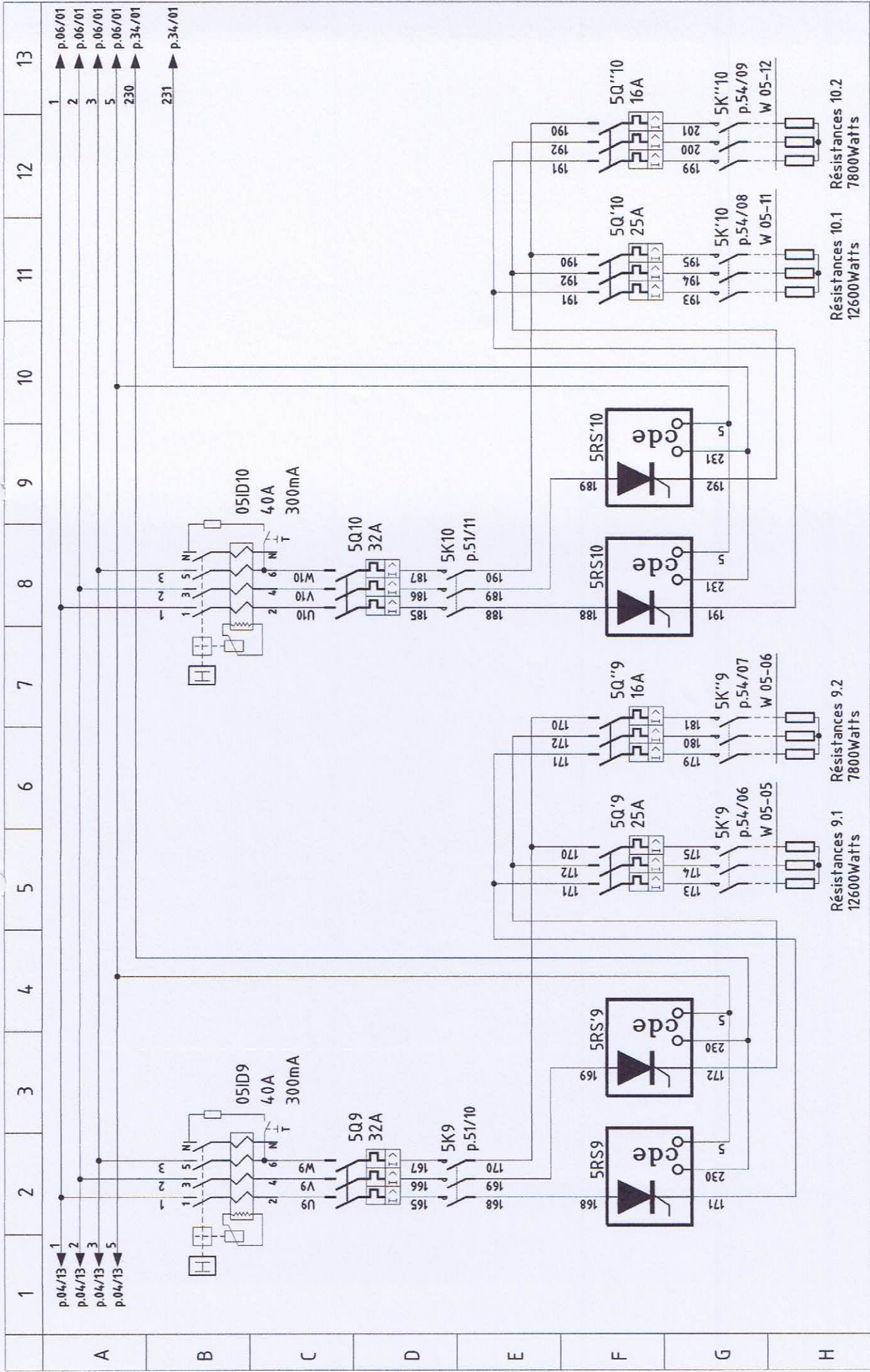

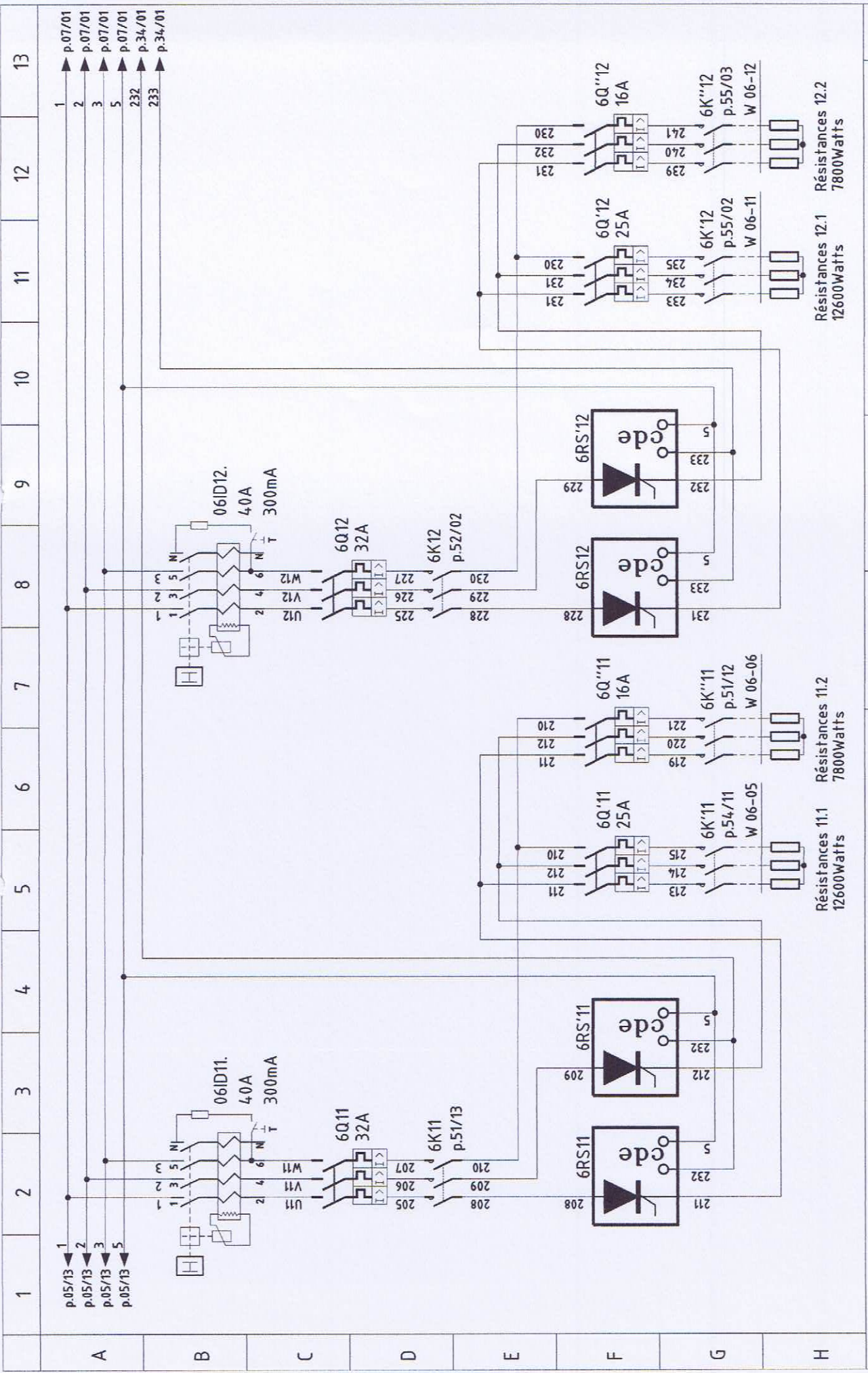

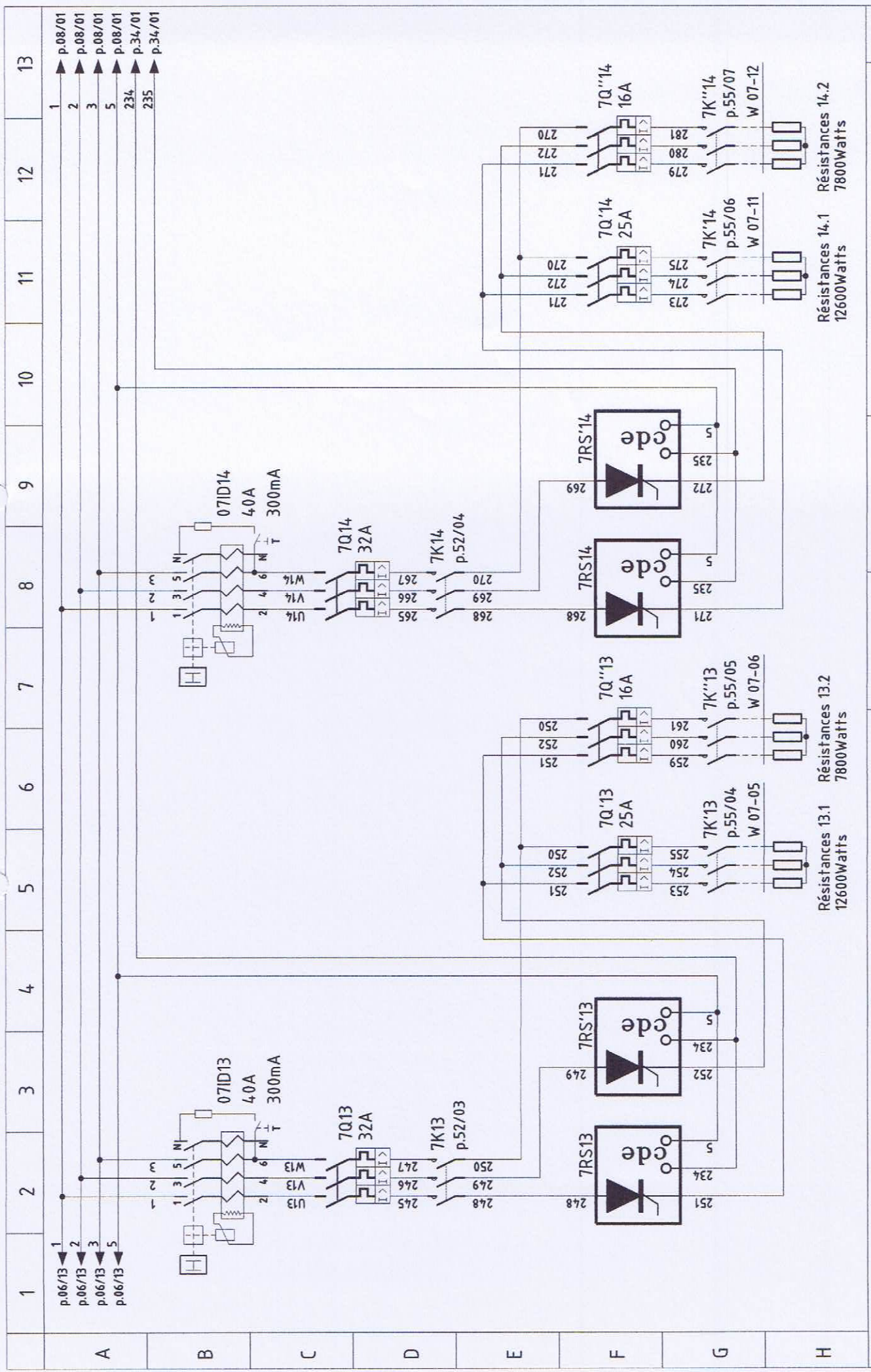

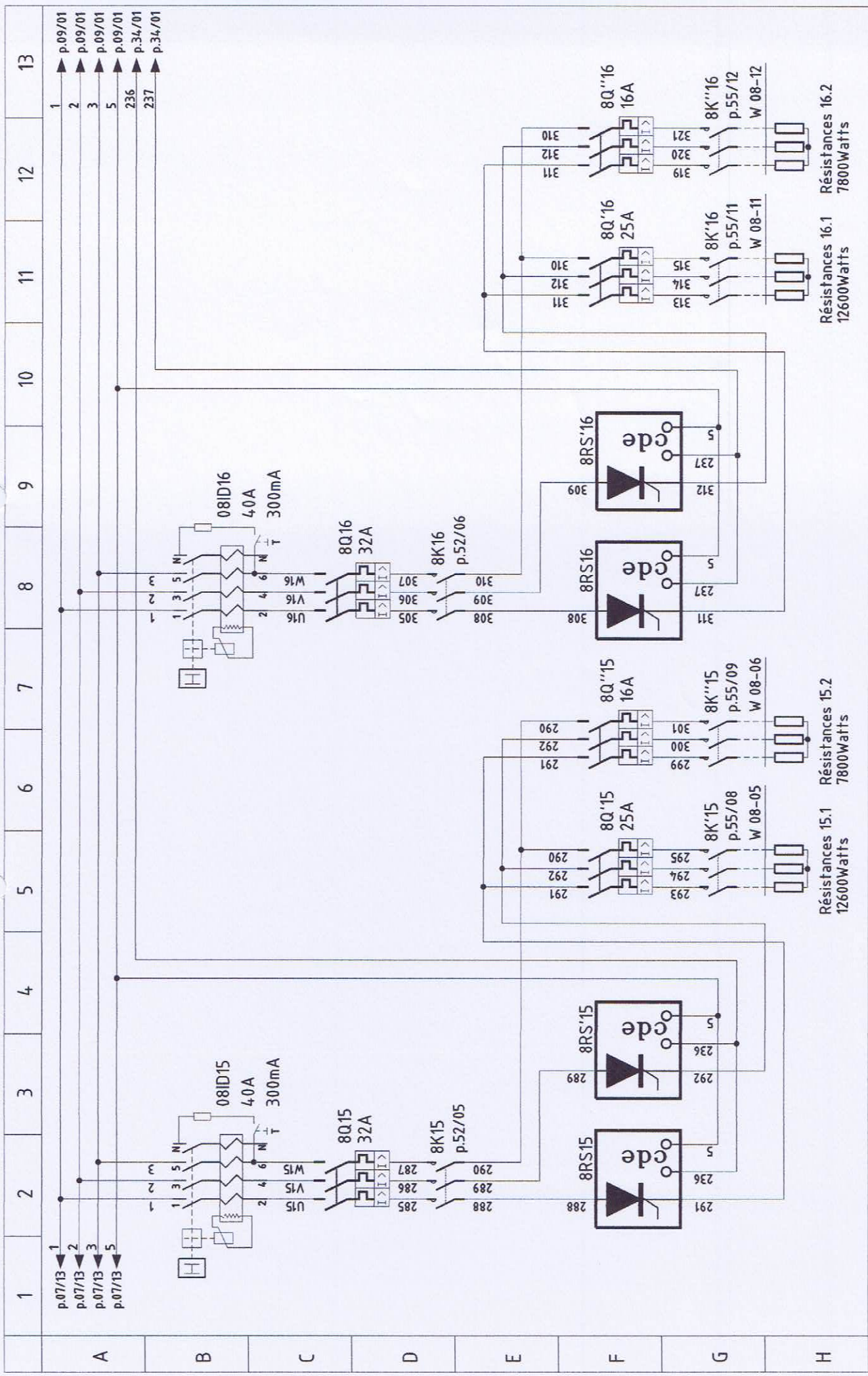

1 2 3 4 5 6 7 8 9 10 11 12 13

p.07/13
p.07/13
p.07/13
p.07/13

1 2 3 5 236 237

p.09/01
p.09/01
p.09/01
p.09/01
p.34/01
p.34/01

1 2 3 4 5 6 7 8 9 10 11 12 13

1 2 3 5 236 237

p.09/01
p.09/01
p.09/01
p.09/01
p.34/01
p.34/01

RESISTANCES ZONES 15 ET 16

CLIENT: IVB MERY SUR SEINE
Réf. Cde: Mail du 20/06/2016 de Mr SIX

DATE : 10/10/2016

FOURS H&C

N° PGE
08

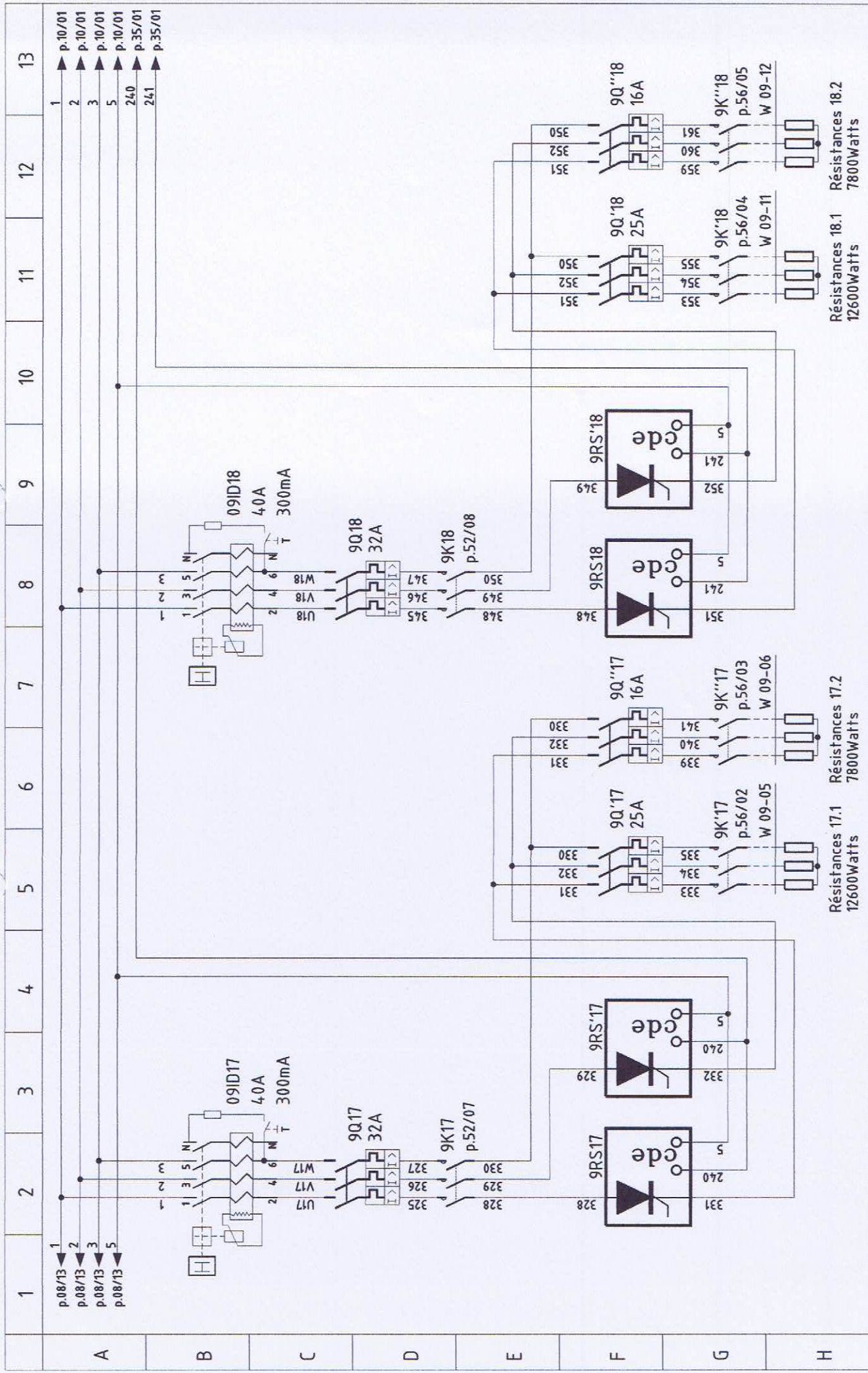

A	B	C	D	E	F	G	H
1	2	3	4	5	6	7	8
p.08/13	p.08/13	p.08/13	p.08/13	p.10/01	p.10/01	p.10/01	p.10/01
1	2	3	4	5	240	241	241
13	12	11	10	9	8	7	6
RESISTANCES ZONES 17 ET 18							
FOURS H&C							
DATE : 10/10/2016							
CLIENT: IVB MERY SUR SEINE Réf. Cde: Mail du 20/06/2016 de Mr SIX							
N° PGE 09							

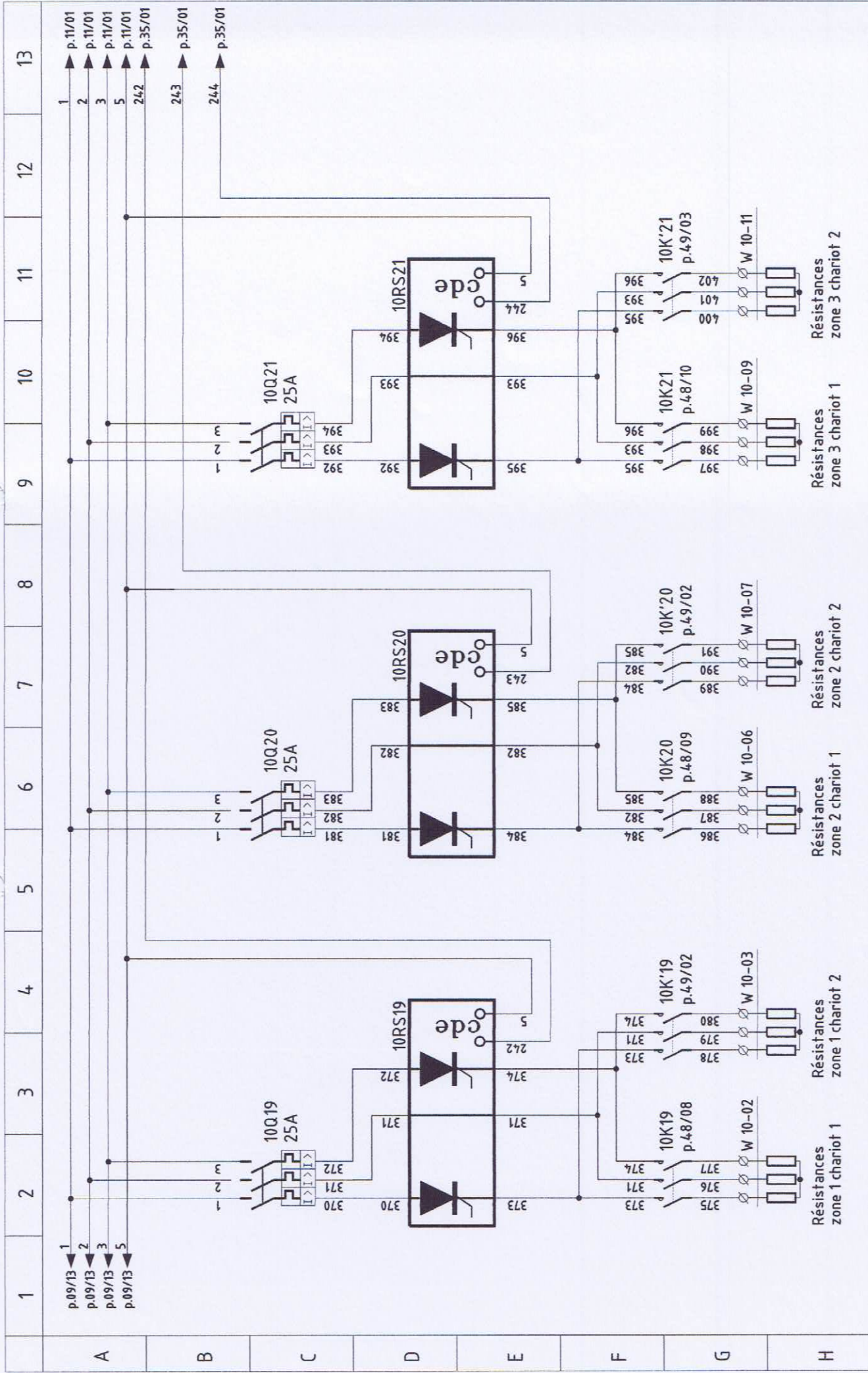

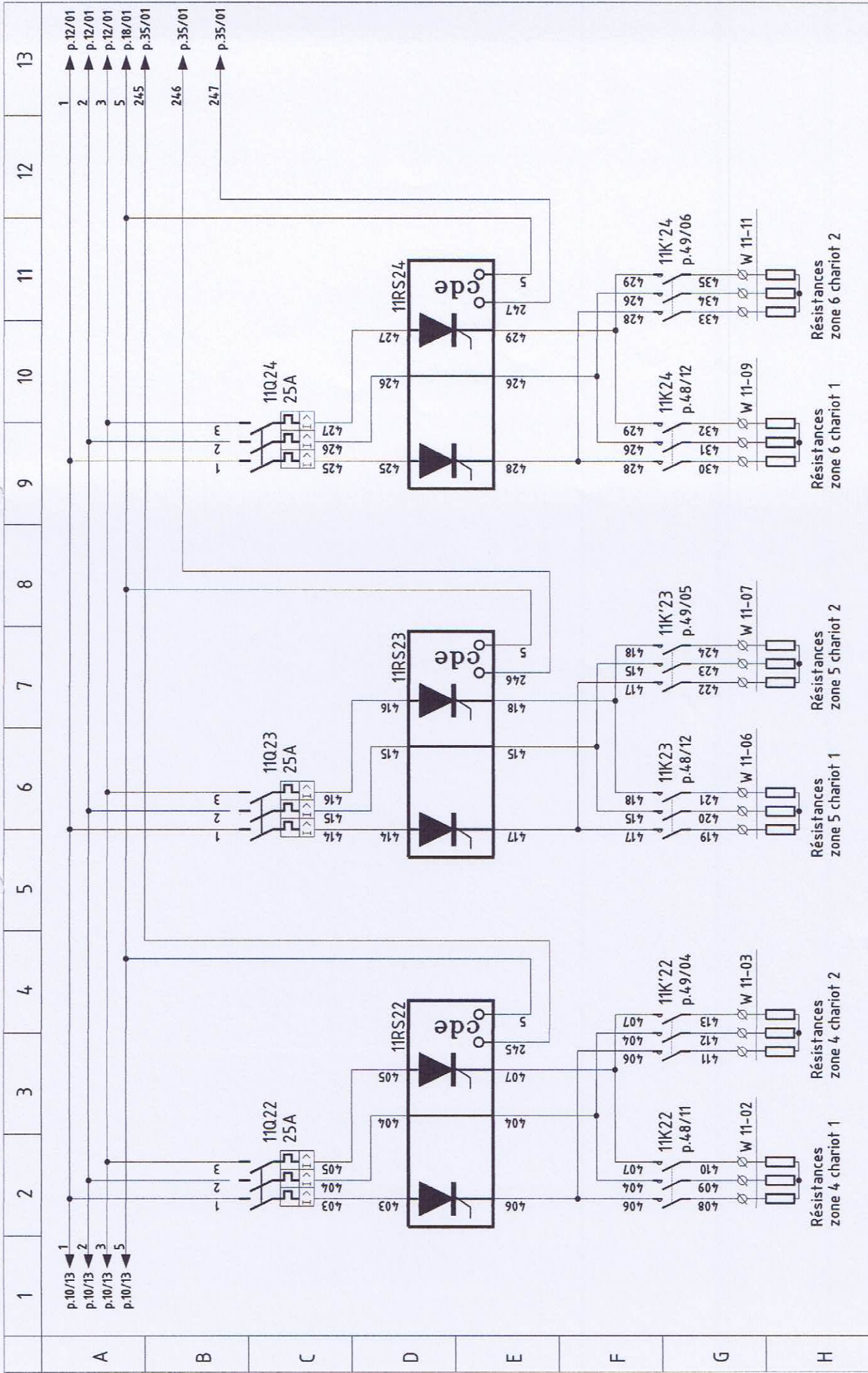

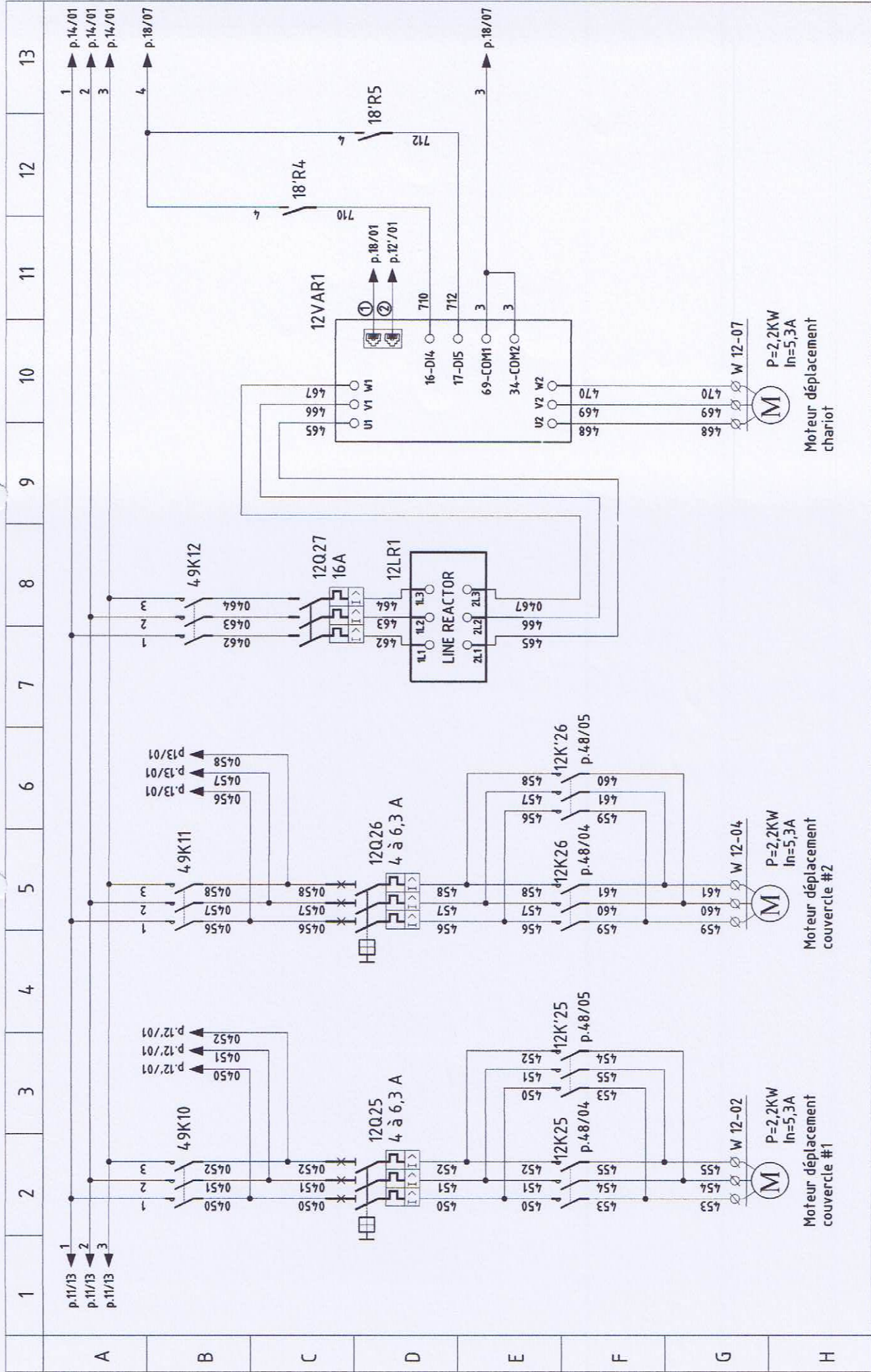

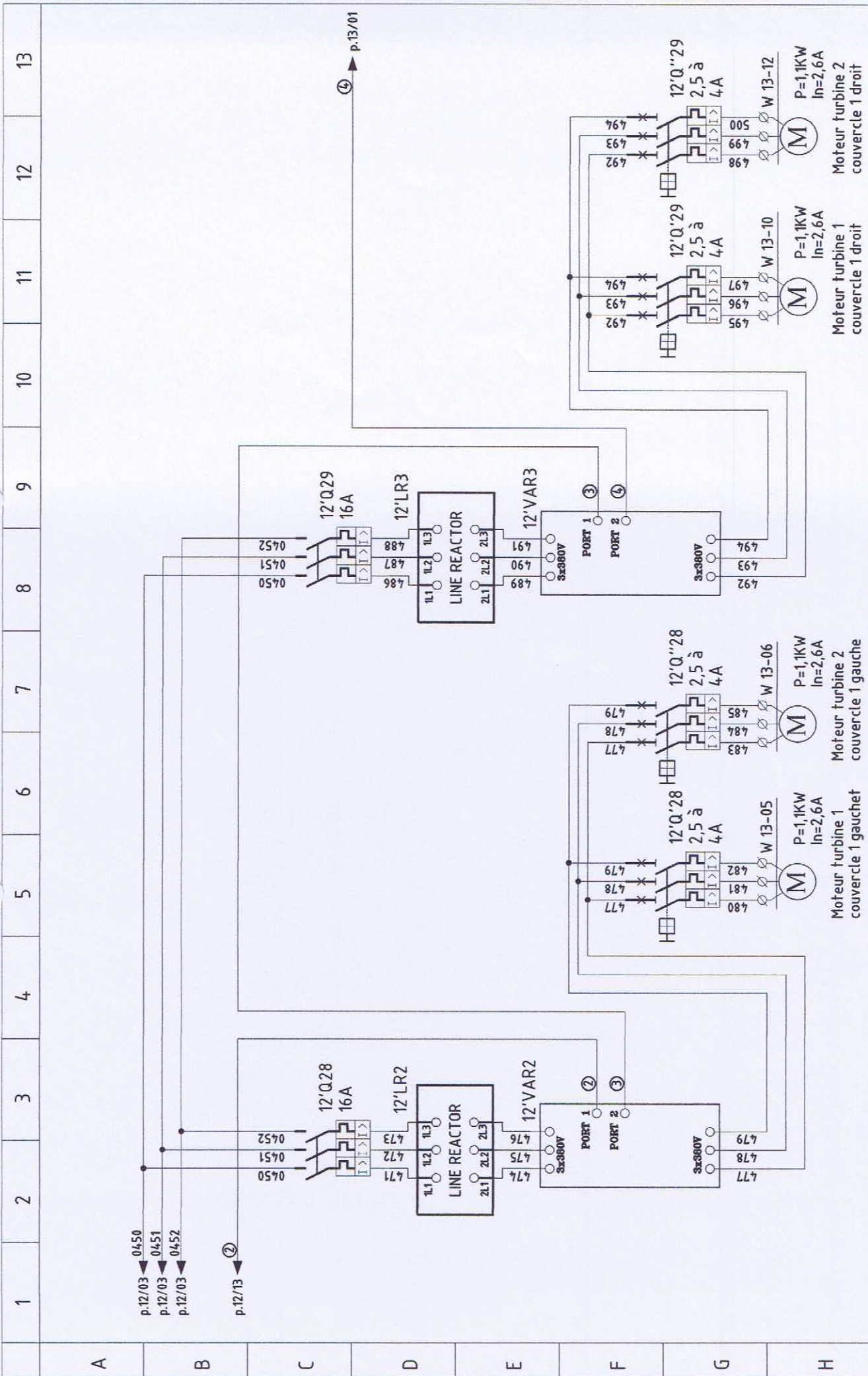

1 2 3 4 5 6 7 8 9 10 11 12 13

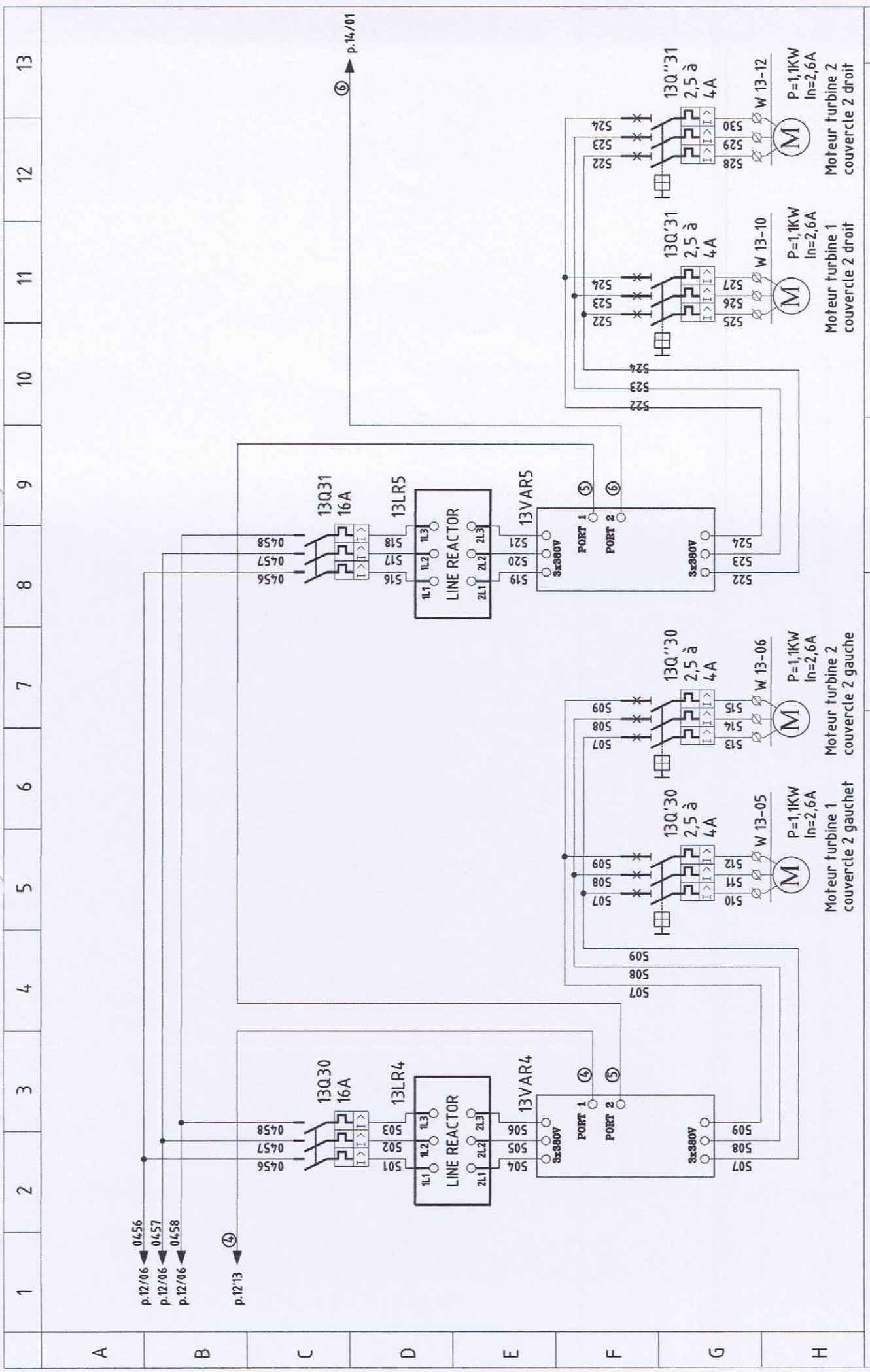

1 2 3 4 5 6 7 8 9 10 11 12 13

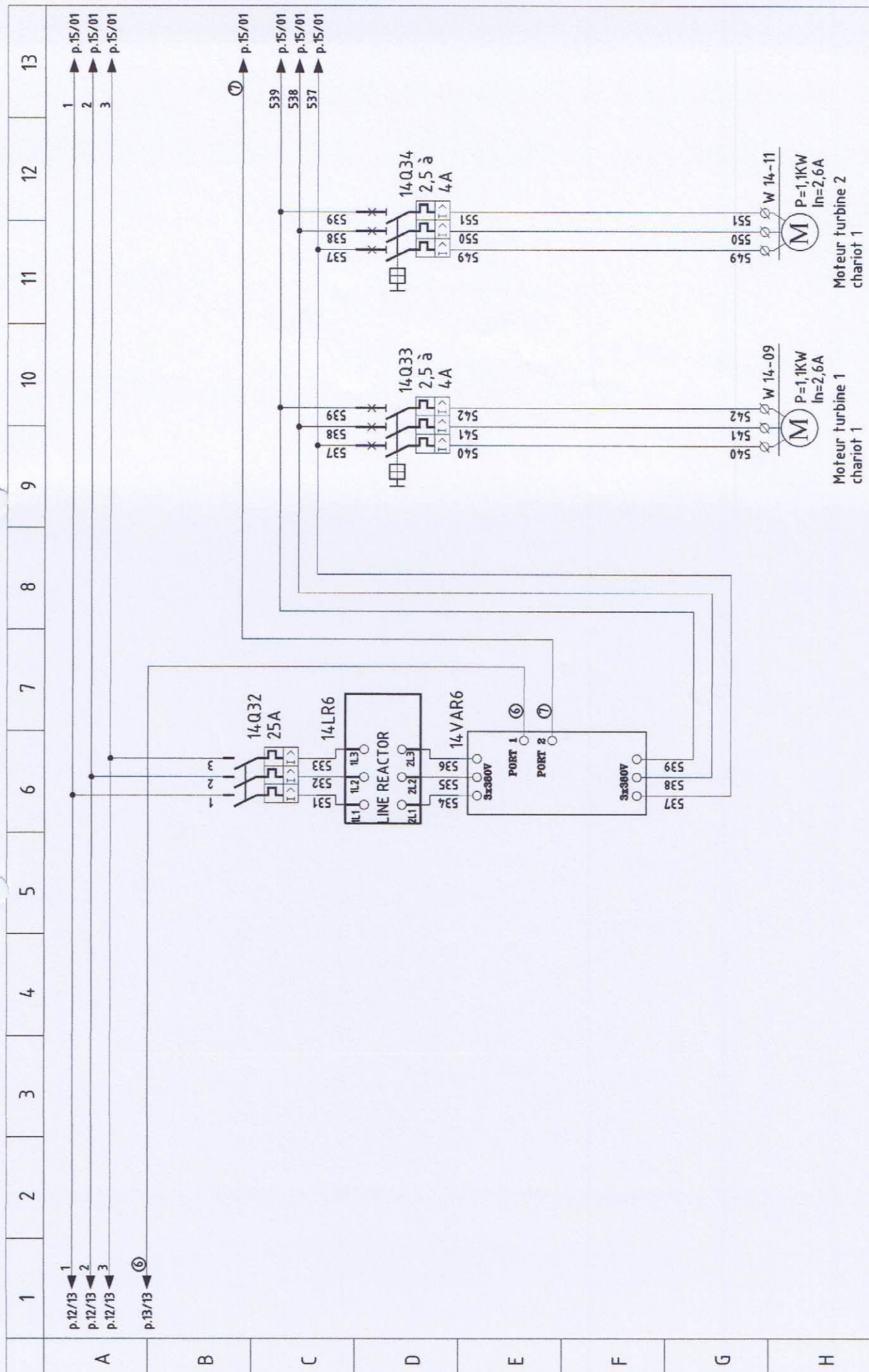

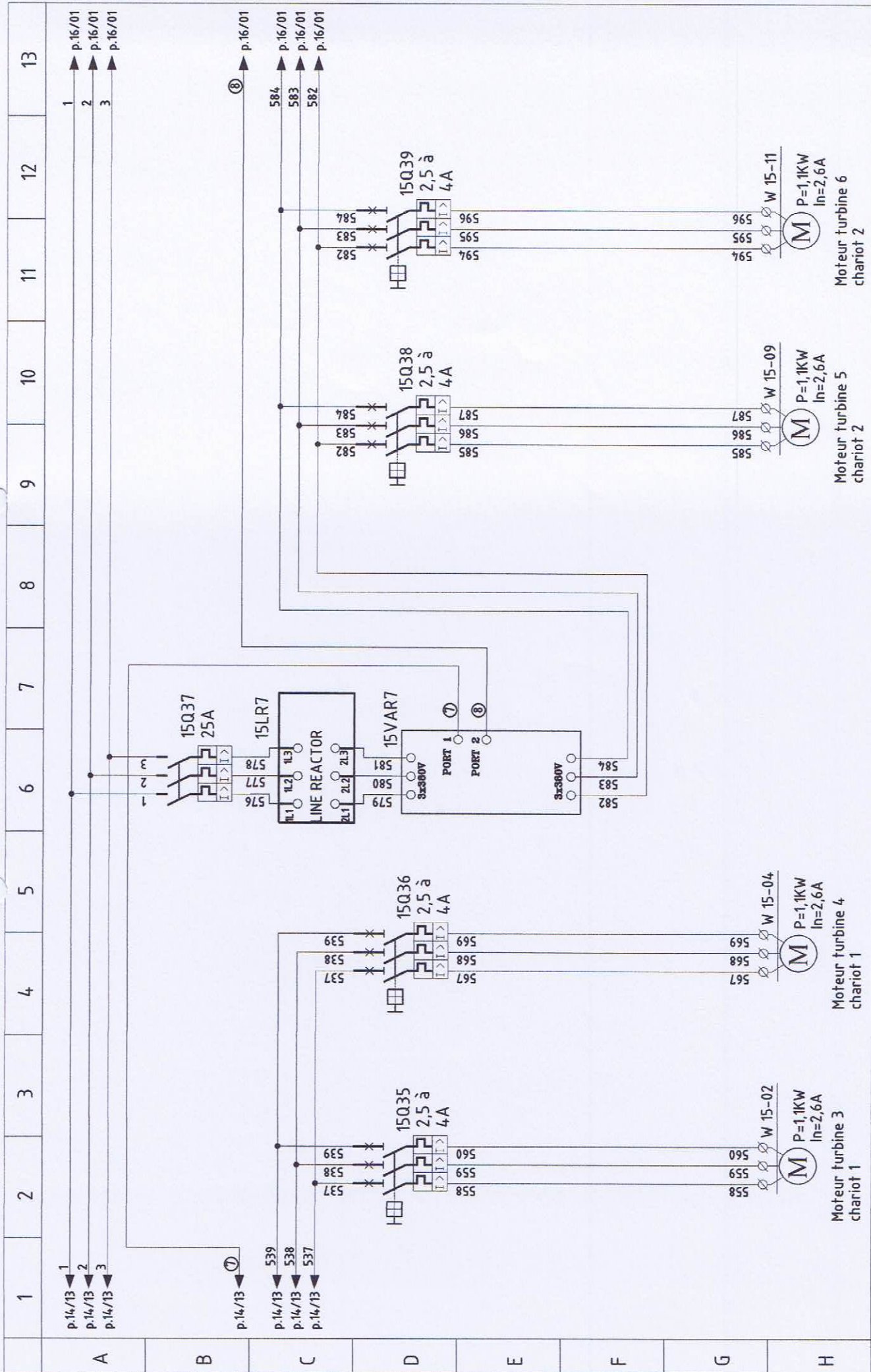

	1	2	3	4	5	6	7	8	9	10	11	12	13
A	1 p.14/13	2 p.14/13	3 p.14/13										1 p.16/01
B													2 p.16/01
C													3 p.16/01
D													⑧ p.16/01
E													584 p.16/01
F													583 p.16/01
G													582 p.16/01
H													

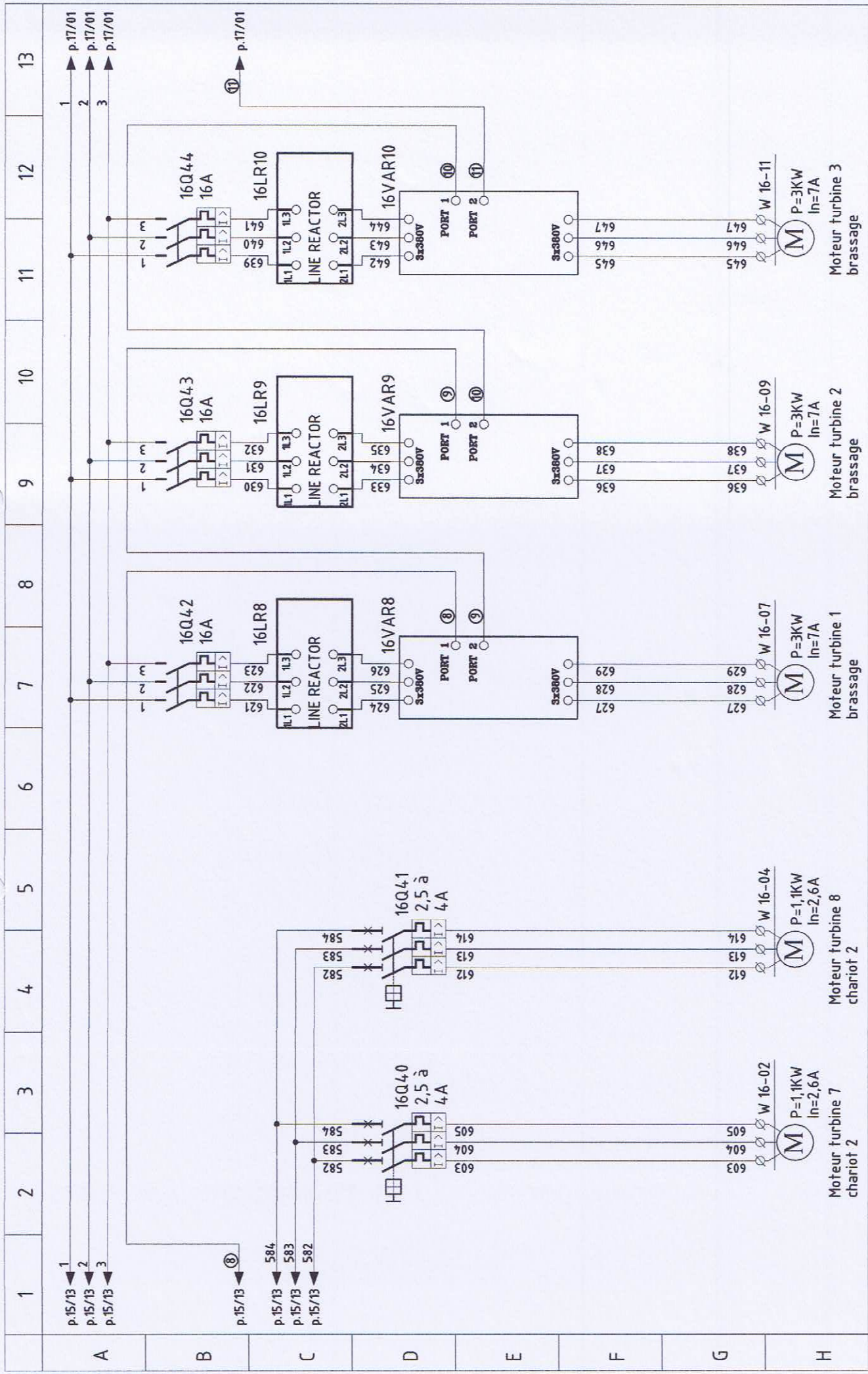

1 p.15/13
 2 p.15/13
 3 p.15/13
 8 p.15/13
 584 p.15/13
 583 p.15/13
 582 p.15/13
 1 p.17/01
 2 p.17/01
 3 p.17/01
 11 p.17/01

A
 B
 C
 D
 E
 F
 G
 H

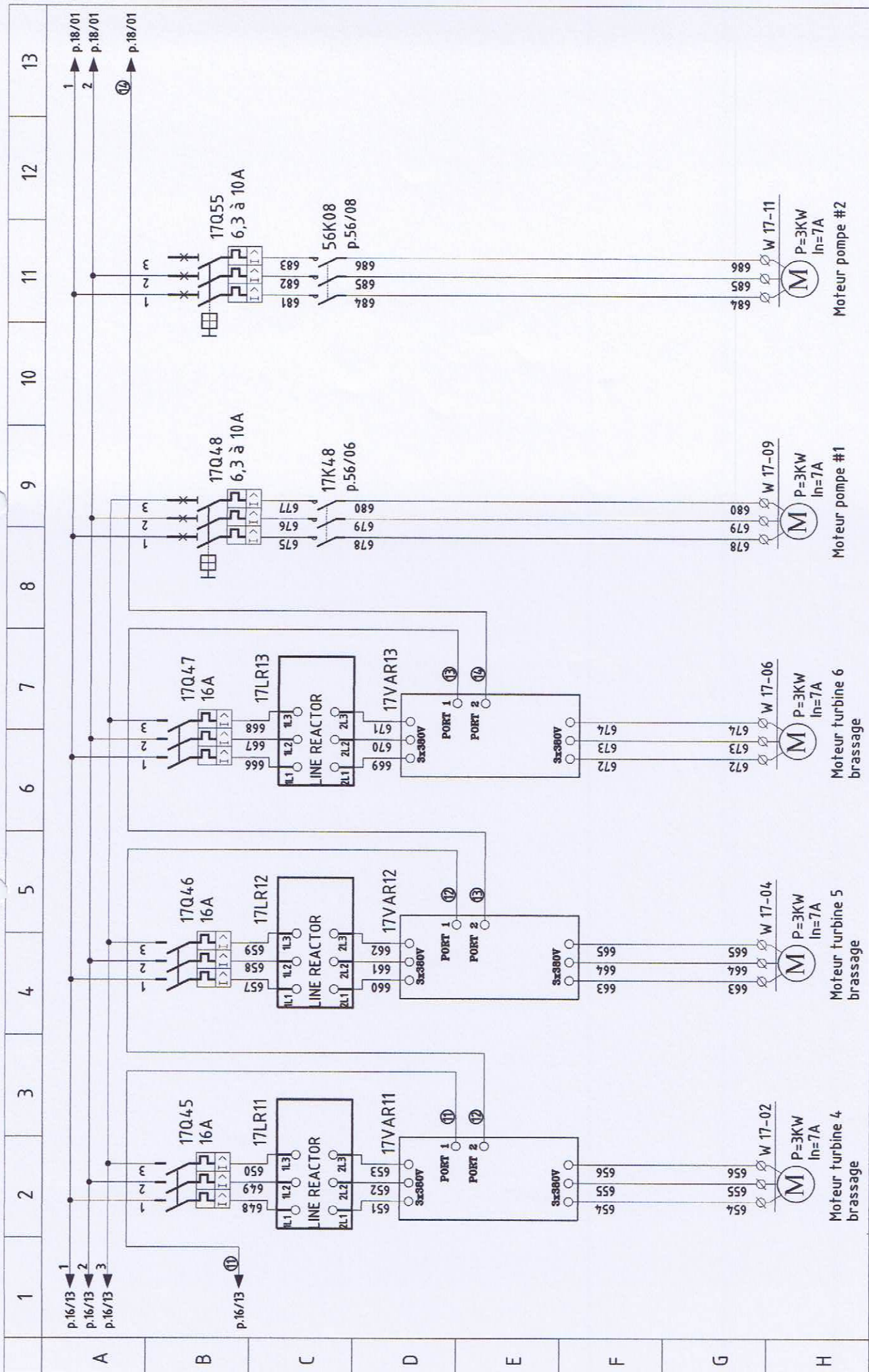

TURBINE BRASSAGE 4 A 6

FOURS H&C

DATE : 10/10/2016

CLIENT: IVB MERY SUR SEINE
Réf. Cde: Mail du 20/06/2016 de Mr SIX

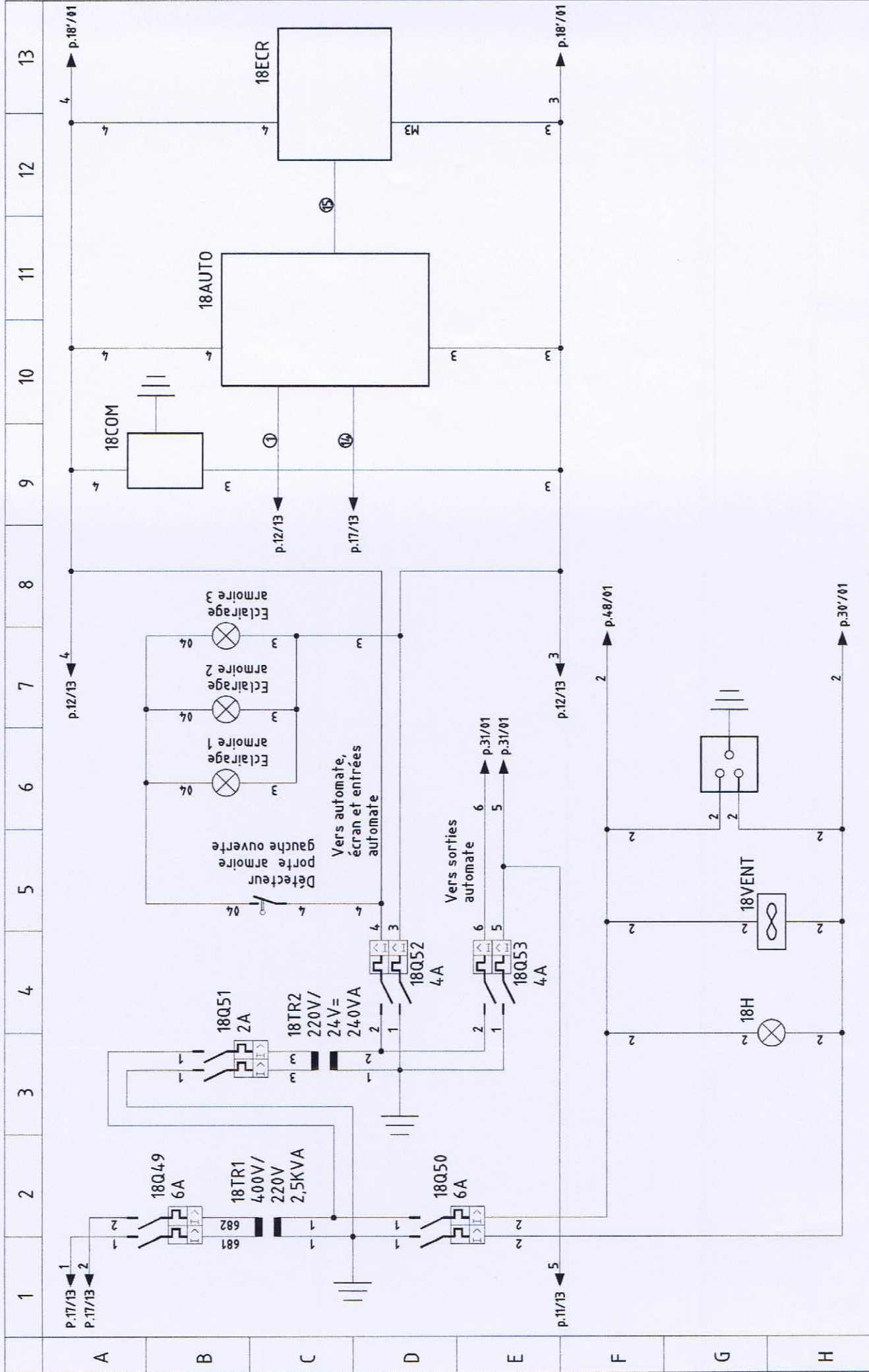

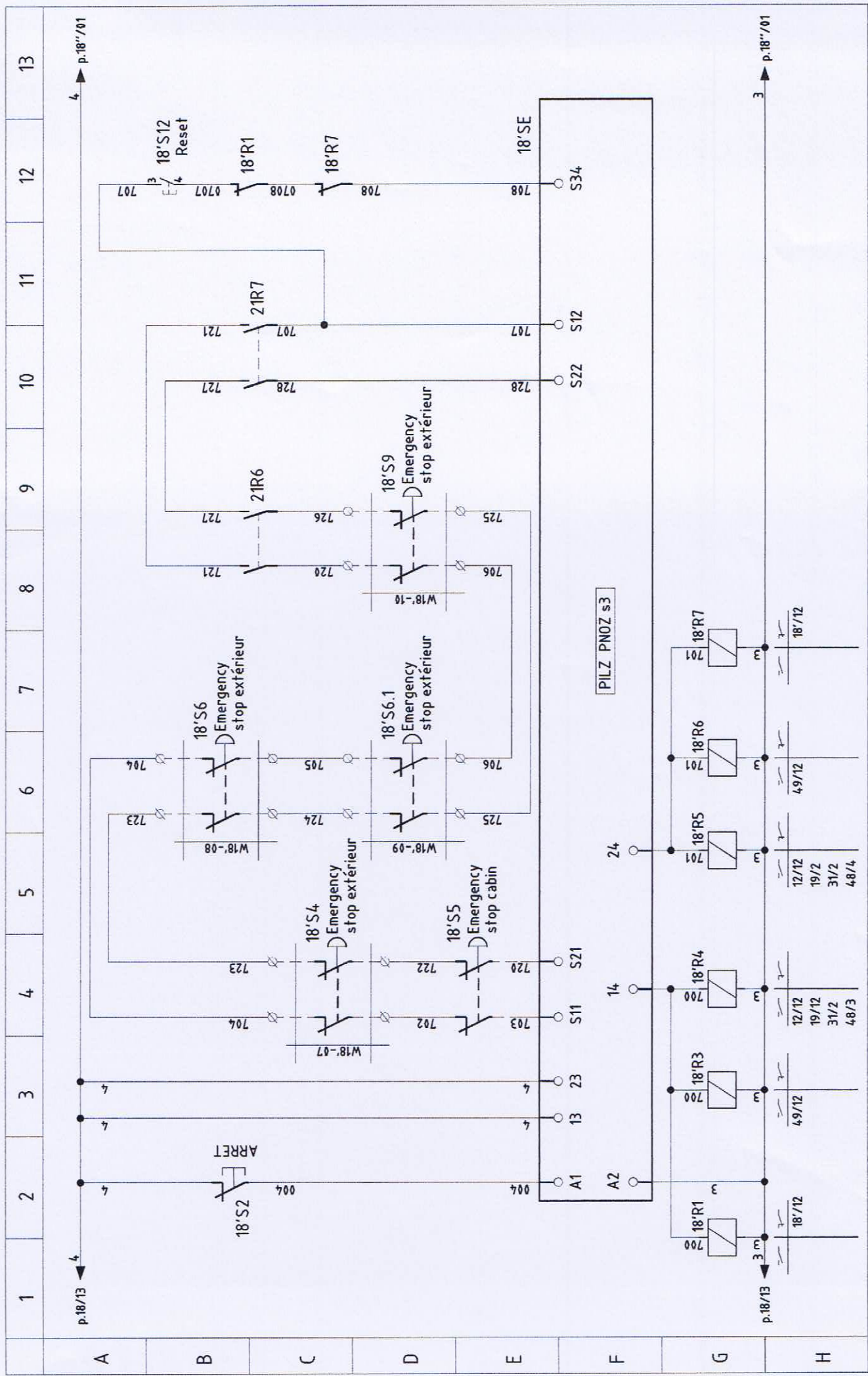

1 2 3 4 5 6 7 8 9 10 11 12 13

p.18/13 ← 4 → p.18"/01

p.18/13 ← 3 → p.18"/01

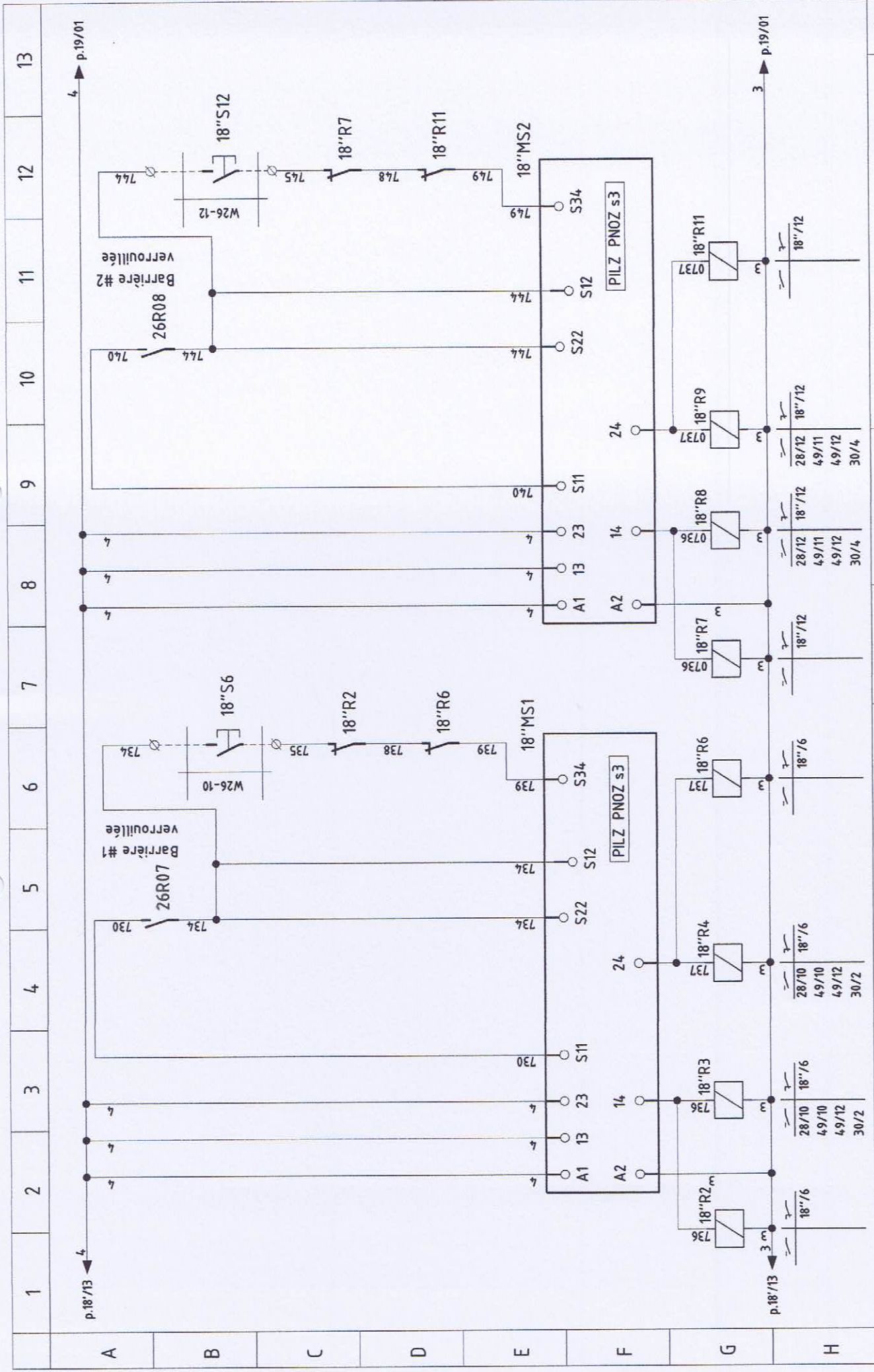

1 2 3 4 5 6 7 8 9 10 11 12 13

p.18''/13 ← 4 → p.19/01

3 → p.19/01

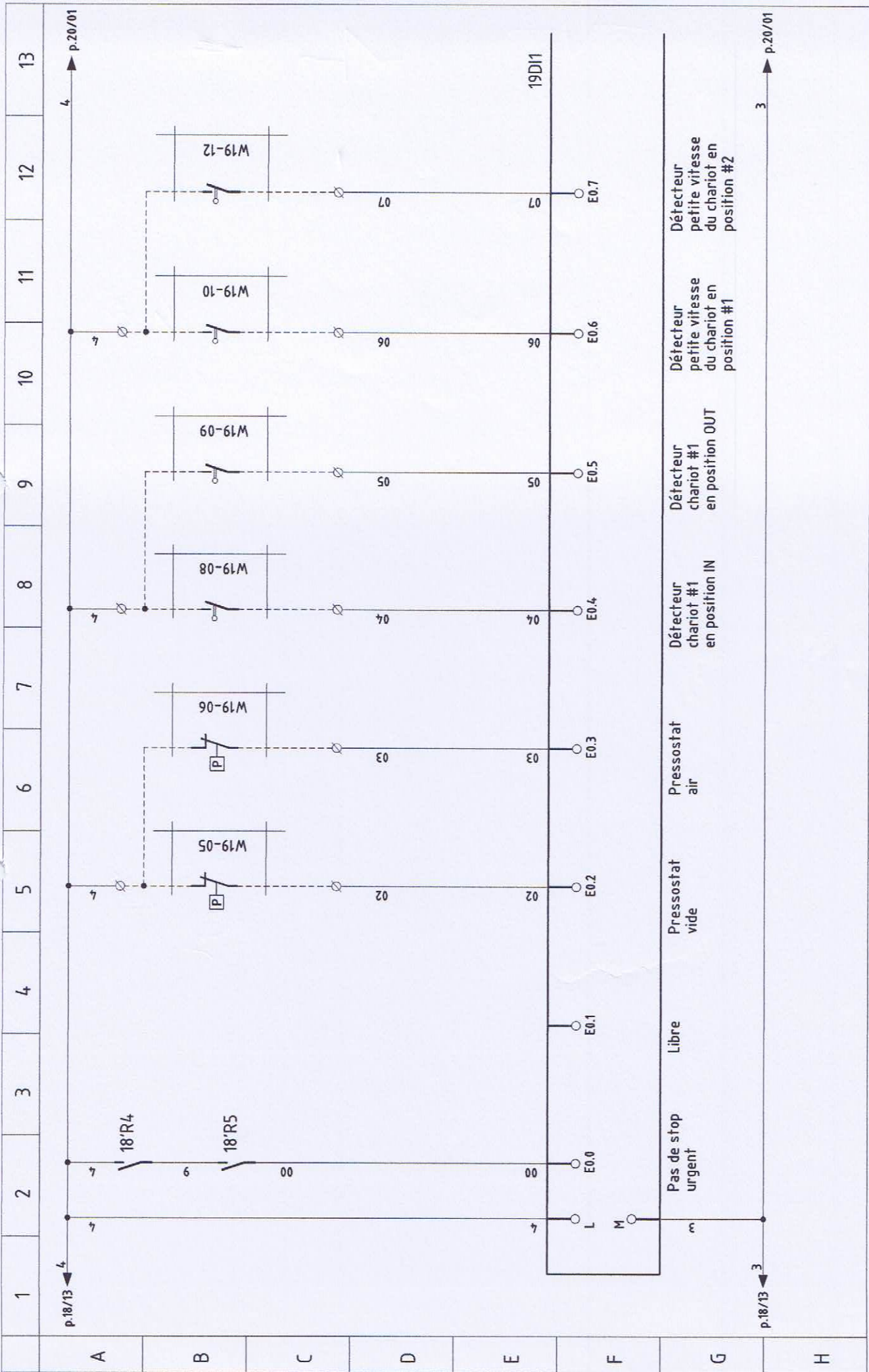

1	2	3	4	5	6	7	8	9	10	11	12	13	
A	B	C	D	E	F	G	H						N° PGE 19
ENTREES AUTOMATE 0.0 A 0.7							FOURS H&C		DATE : 10/10/2016		CLIENT: IVB MERY SUR SEINE Réf. Cde: Mail du 20/06/2016 de Mr SIX		

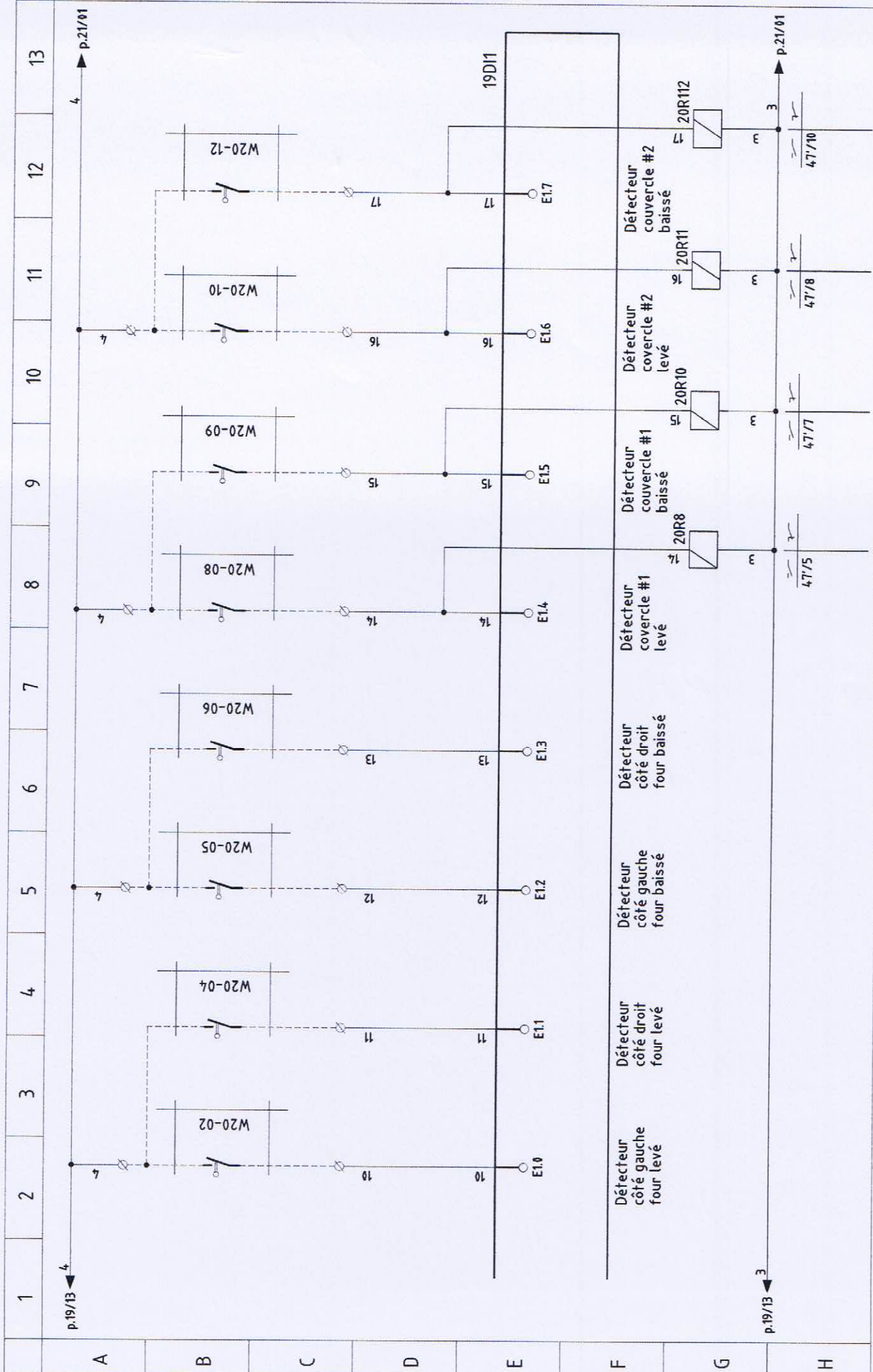

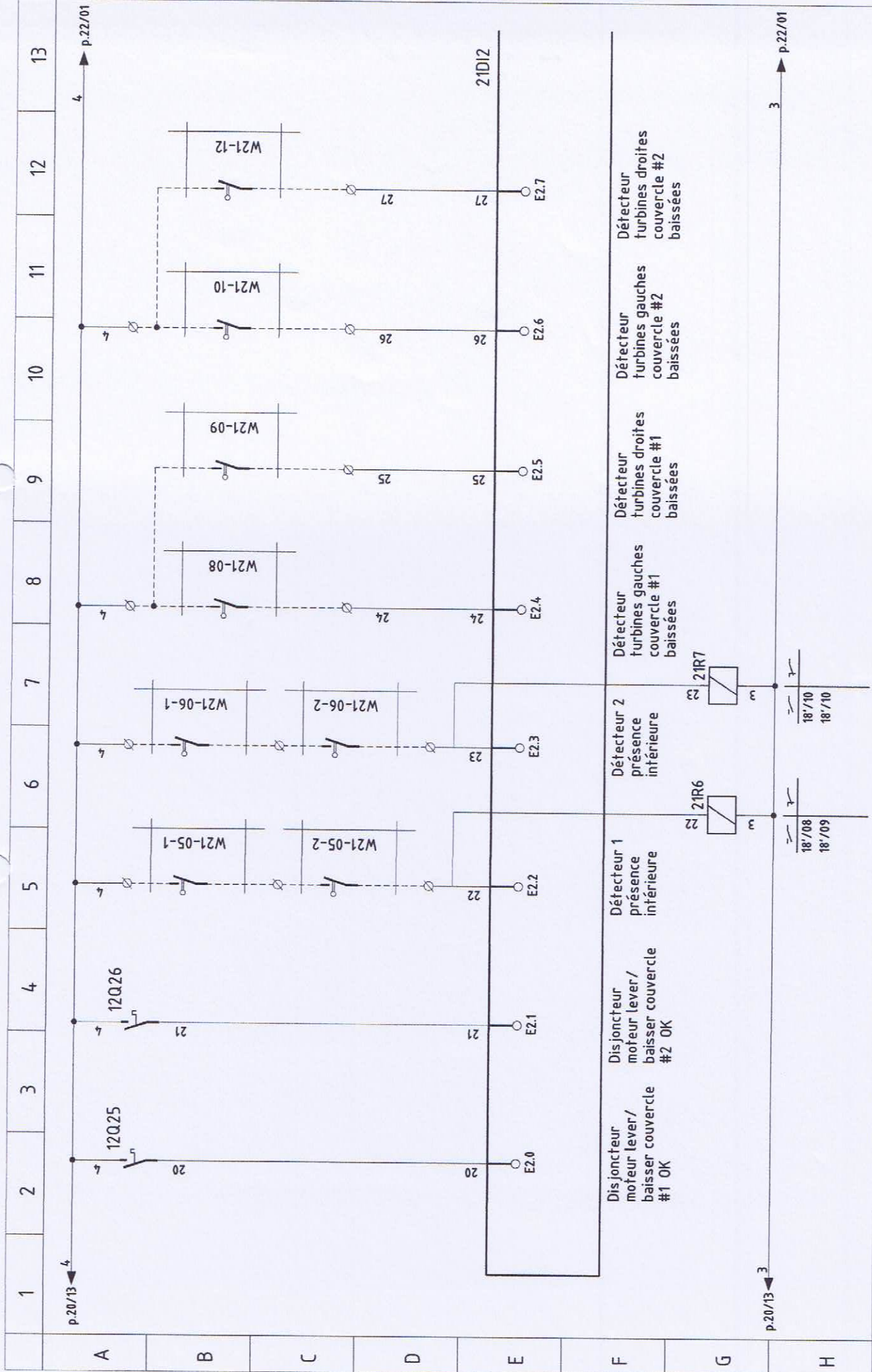

ENTREES AUTOMATE 2.0 A 2.7

FOURS H&C

DATE : 10/10/2016

CLIENT: IVB MERY SUR SEINE
 Réf. Cde: Mail du 20/06/2016 de Mr SIX

N° PGE
 21

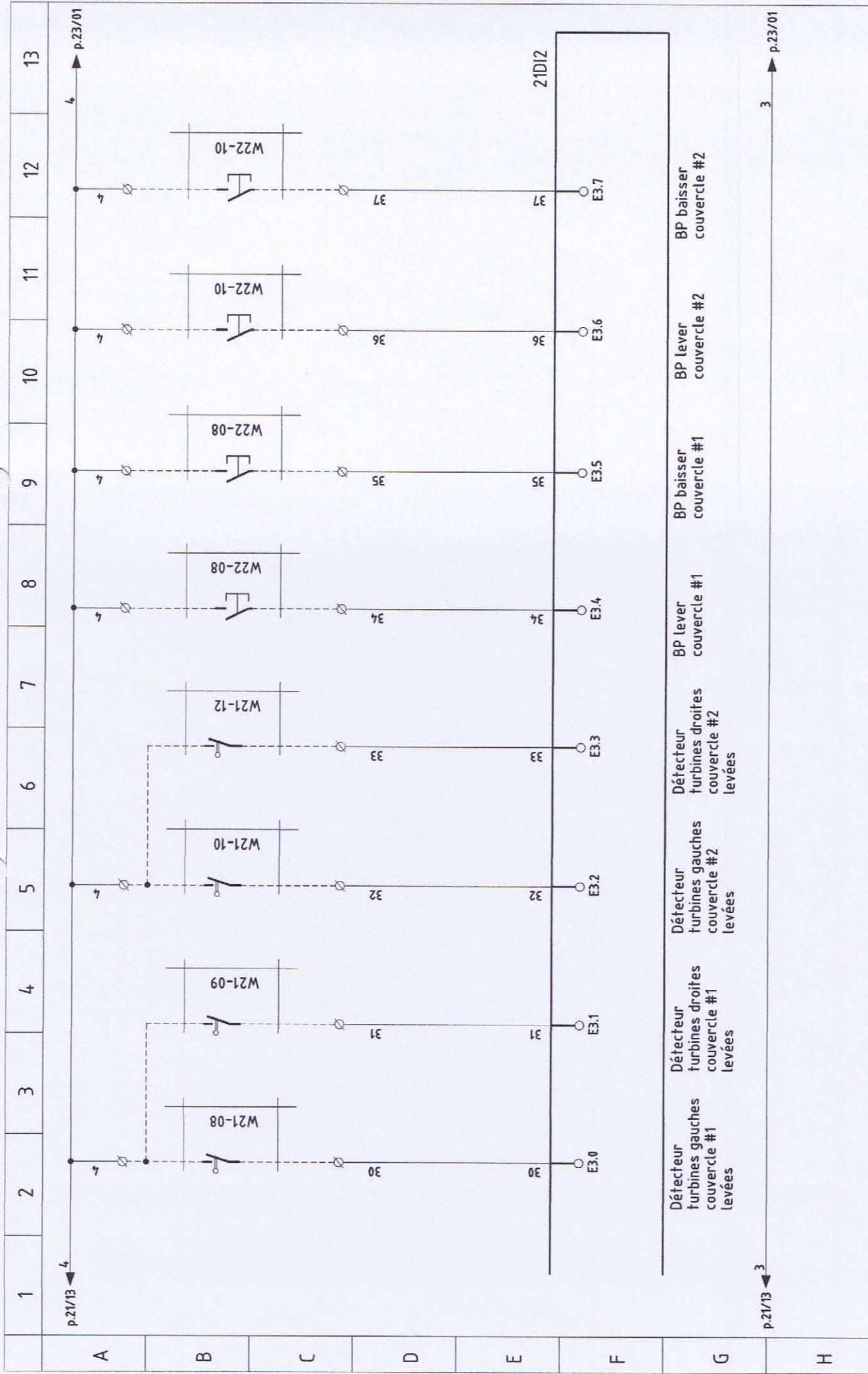

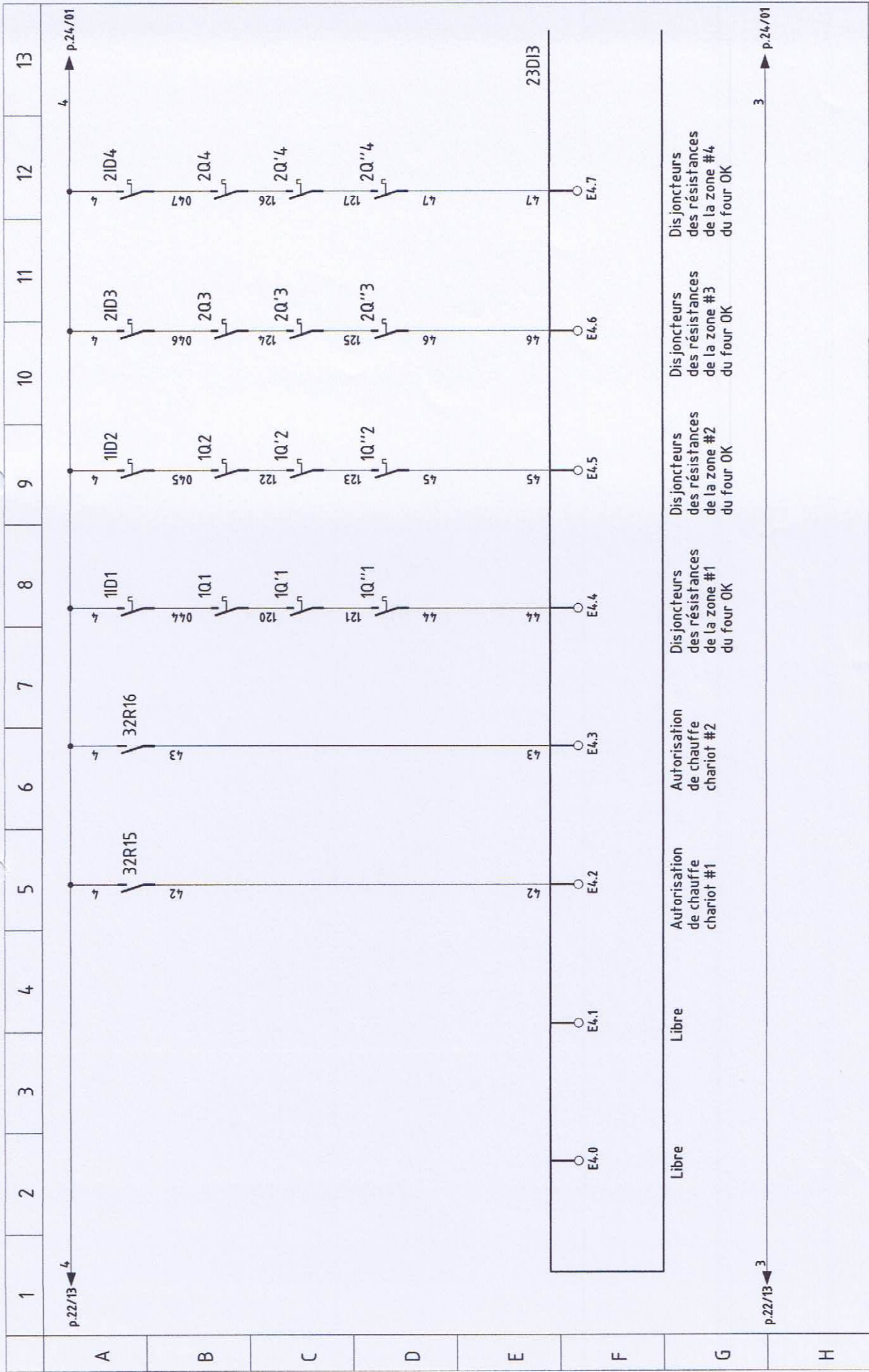

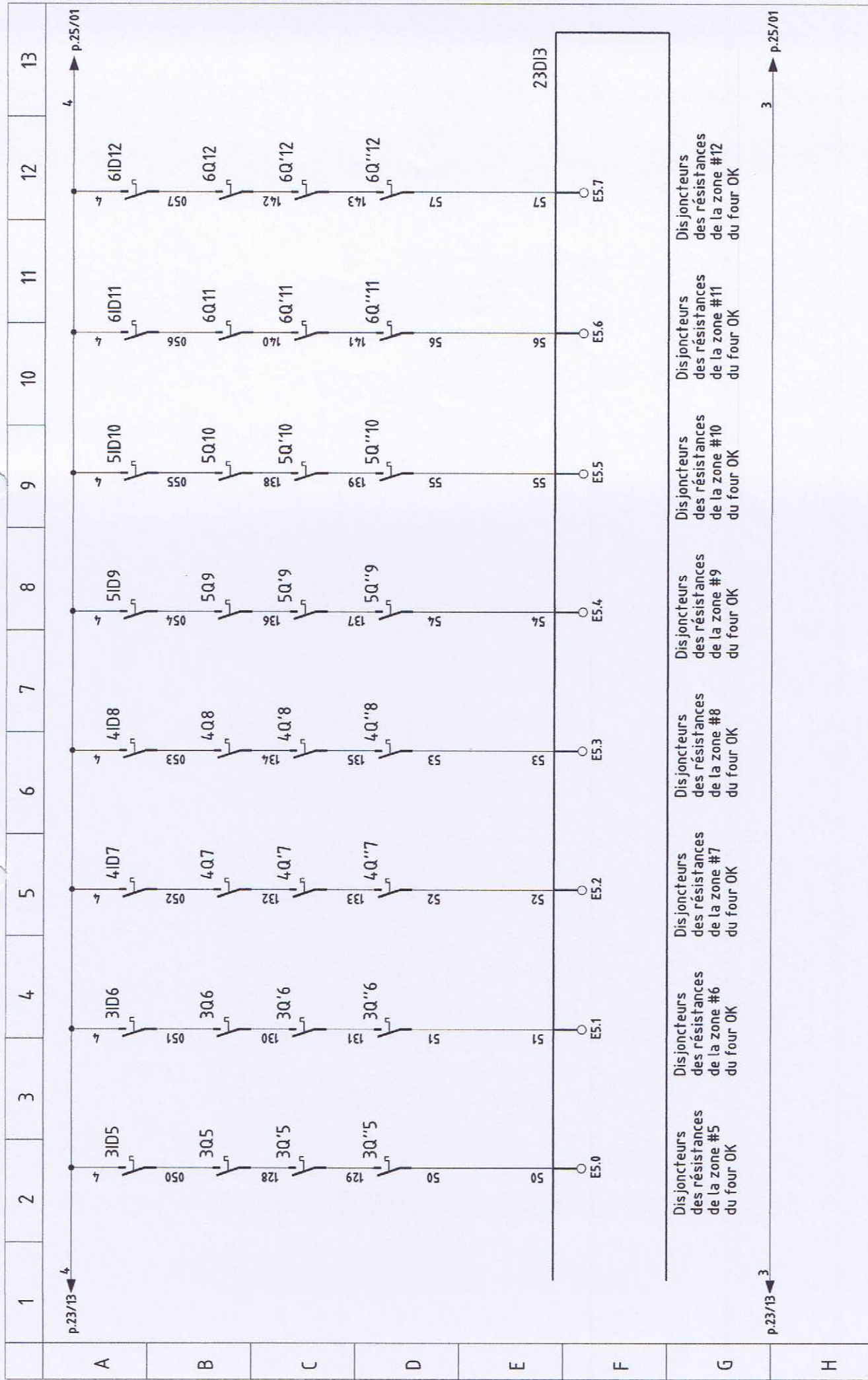

ENTREES AUTOMATE 5.0 A 5.7	FOURS H&C	DATE : 10/10/2016	CLIENT: IVB MERY SUR SEINE Réf. Cde: Mail du 20/06/2016 de Mr SIX	N° PGE 24
----------------------------	-----------	-------------------	--	--------------

